

BOX wersja 1

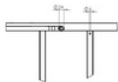

SZCZEGÓŁ a
SKALA 1:1

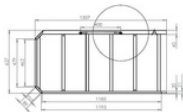
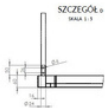
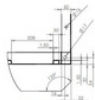
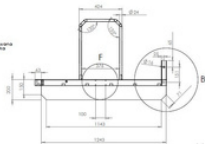
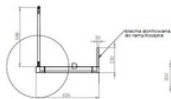

SZCZEGÓŁ a
SKALA 1:1



SZCZEGÓŁ a
SKALA 1:1

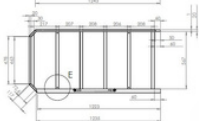

SZCZEGÓŁ a
SKALA 1:1

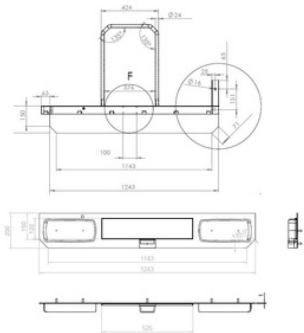



SZCZEGÓŁ A
SKALA 2:1

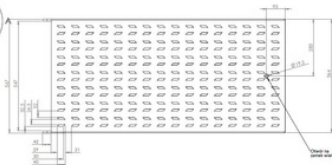

ZAMEK
WIELOZAPADKOWY

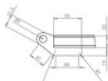

SZCZEGÓŁ B
SKALA 2:1



SZCZEGÓŁ D

Otwór na
zamek wielozapadkowy

uszczelnienie
uszczelnienie
uszczelnienie



SZCZEGÓŁ E
SKALA 2:1

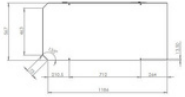
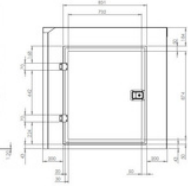

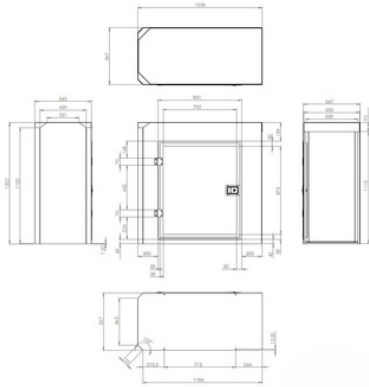

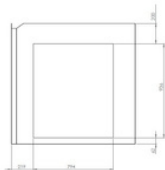

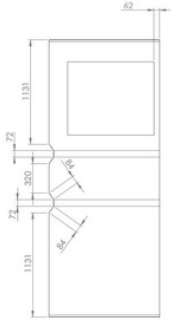
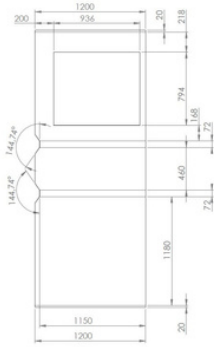



ZAKŁASZ (ROZKŁADANY) 70x40 PRAM. KOWAL

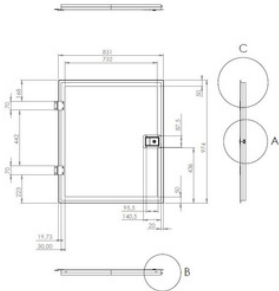

SZCZEGÓŁ c
SKALA 1:5



SZCZEGÓŁ a
SKALA 1:5



SZCZEGÓŁ b
SKALA 1:5



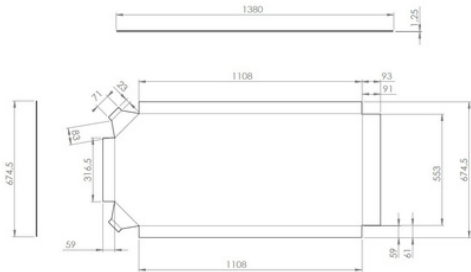

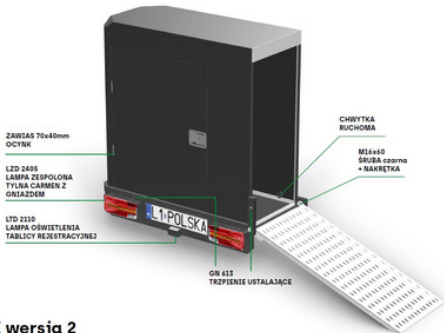

BOX wersja 2

1 mm blacha lub cienka płyta warstwowa
oponera profilu 20x20x1.5mm

SZCZEGÓŁ A
SKALA 1:1

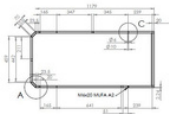

MUFA M6 x 20 x 4set
+ POKRĘTŁO GWIAZDOWE

SZCZEGÓŁ c
SKALA 1:1

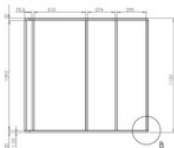
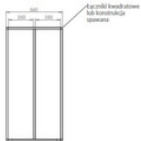

SZCZEGÓŁ b
SKALA 1:1



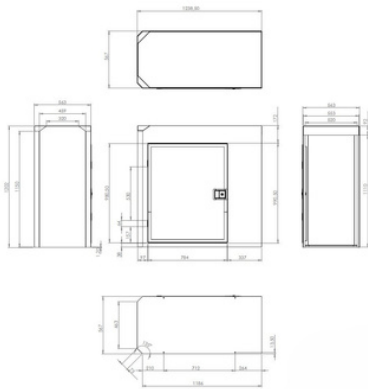

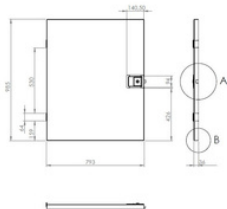

SZCZEGÓŁ A
SKALA 1 : 5

SZCZEGÓŁ B
SKALA 1 : 5